

系统供电稳压

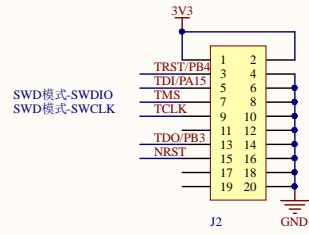

调试JTAG、SWD接口

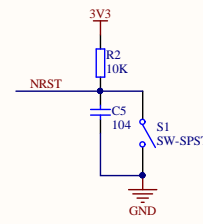

系统复位

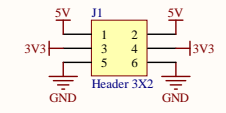

扩展供电接口

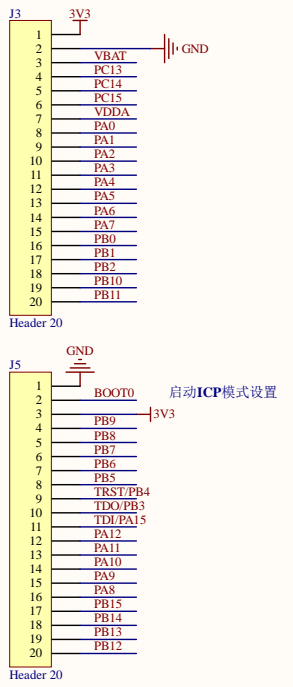

通用I/O接口

CPU系统

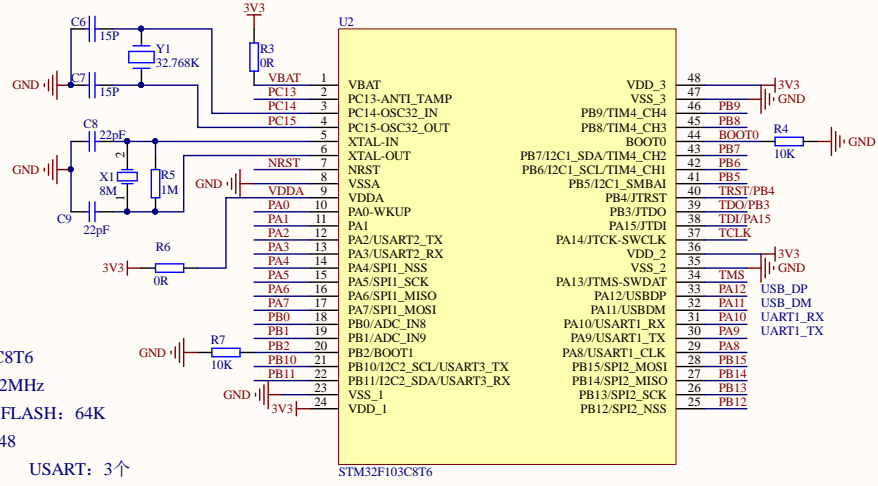

CPU简介

STM32F103C8T6

CPU频率: 72MHz

RAM: 20K FLASH: 64K

封装: LQFP48

通用I/O: 32 USART: 3个

SPI: 2个 USB: 1个

CAN: 1个 IIC: 2个

12位同步ADC: 2组 10通道

工作电压: 2.0至3.6V

具体详细功能分配请以数据手册为准

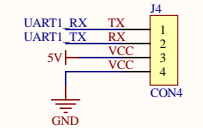
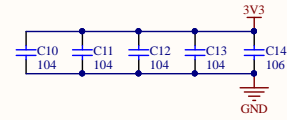

蓝牙模块



LDE灯模块

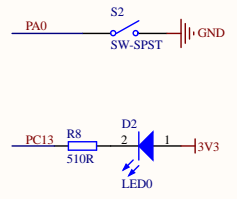

按键和LED灯

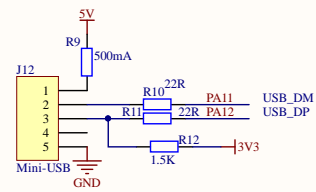

供电及STM32-USB Slave

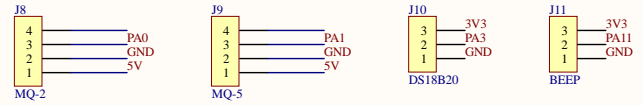

外设模块

Title		
Size	Number	Revision
A3		
Date:	2022/5/1	Sheet of
File:	E:\项目\STM32 Smart.SchDoc	Drawn By:

Board Stack Report