

温度传感器接口

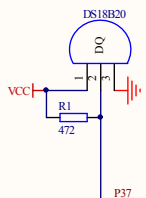

红外接收头接口

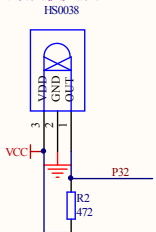

蜂鸣器模块

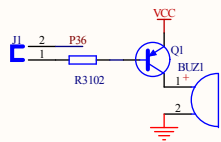

独立键盘

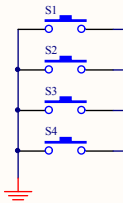

红外发射模块

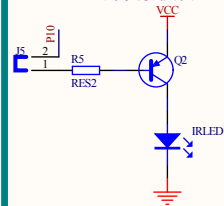

AVR下载接口

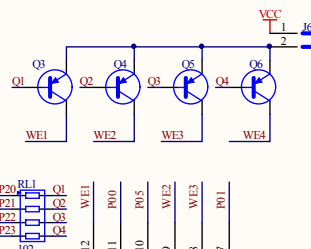
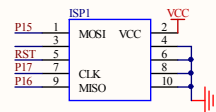

LED流水灯模块

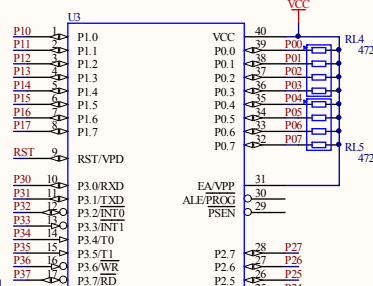
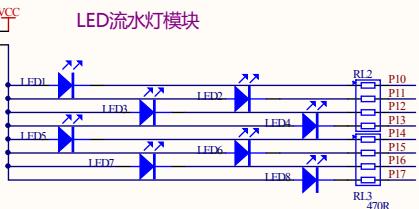

主控芯片

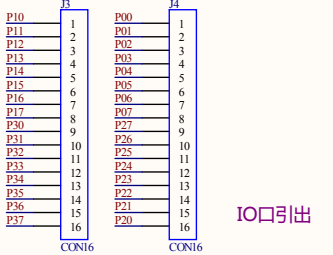

IO口引出

4位共阳数码管

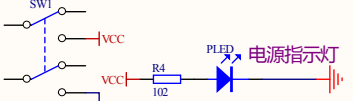
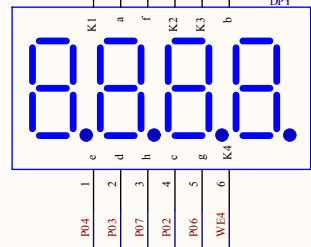

供电&下载&串口模块通信

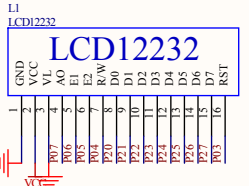
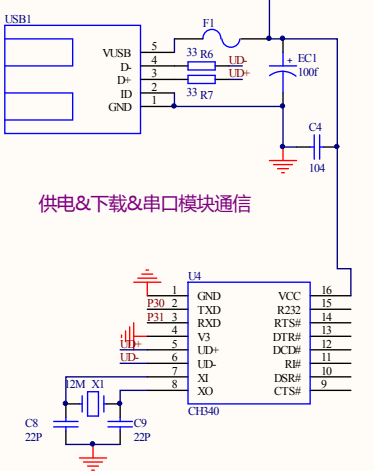

LCD液晶接口

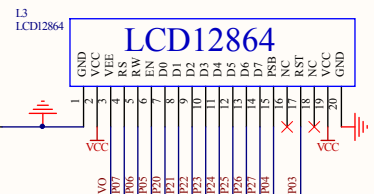
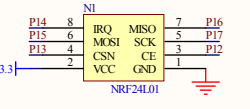
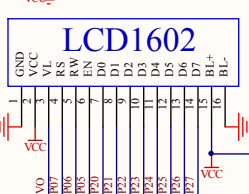

复位电路

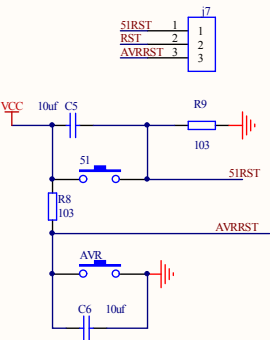

清翔电子51单片机开发板
型号: QX-Mini51
版本: V1.0
WEB: WWW.QXMCU.COM